

DENTAL CURING LIGHT

User Manual

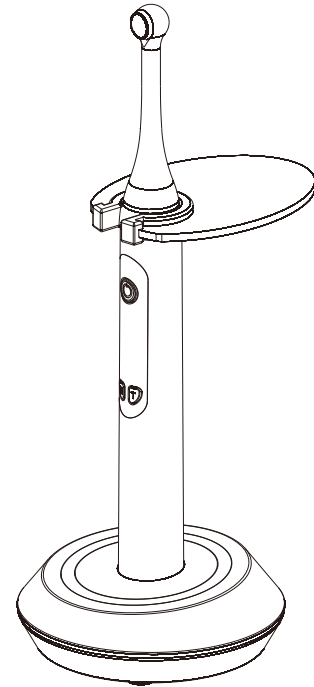

This product is a new type curing light that uses high power and high purity broad spectrum blue-violet LED with a wavelength of 385–515nm as light source and an enhanced condenser lens. It is suitable for most composite resins on the market.

This curing light has 4 working modes for users to use in different working environments. The working head can be rotated 360 degrees for easy operation.

1. Basic Information

[Main structure composition] It is composed of a main body, a working head, a filter, a lithium battery, and a charging device.

2. Product structure and composition

- 1-Working head
- 2-Filter
- 3-Main body
- 4-Charging base

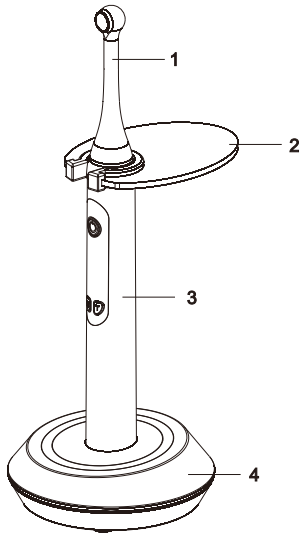

3. Product performance

- 3.1 Electrical safety classification: Class II; Internal power supply; Type B applied part
- 3.2 Power adapter
 - 3.2.1 Input voltage: AC100–240V ~ 50/60Hz
 - 3.2.2 Output voltage: DC5V \pm 1.0A
- 3.3 Lithium battery
 - 3.3.1 Model: 186501S1P
 - 3.3.2 Type: rechargeable lithium battery
 - 3.3.3 Capacity: 2200mAh
 - 3.3.4 Internal power supply voltage: DC3.7V
- 3.4 Optical parameters
 - 3.4.1 Wave length: 385~515nm
 - 3.4.2 Radiation in the 385–515nm wavelength range: $\geq 1500\text{mw}/\text{cm}^2$

4. Operating environment

- 4.1 Temperature range: 5~40°C
- 4.2 Relative humidity range: $\leq 80\%$
- 4.3 Air pressure range: 75 kPa ~ 106kPa
- 4.4 Voltage: DC3.7V
- 4.5 Avoid using this product in an environment with electromagnetic interference (such as near a microwave oven, etc.).
- 4.6 The charger of this product should meet the requirements of GB9706.1–2007.

5. Instructions

- 5.1 Button
 - 1–Power switch ()
 - 2–Battery indicator
 - 3–Mode setting (M)
 - 4–Mode indicator area
 - 5–Time display area
 - 6–Time setting (T)

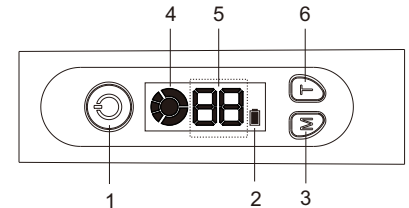

Mode 01 flash mode (⚡)

It can be selected within 5–40 seconds, each setting time is 5s.
The curing light works for 1s, stops for 1s, until the timing ends.
The buzzer will prompt with "di" every 5 seconds.

Mode 02 gradually strong mode (↗)

It can be selected within 5–40 seconds, each setting time is 5s.
The power of the curing light is gradually increased in the first 5s,
and the remaining time is the standard power, until the timing ends.
The buzzer will prompt with "di" every 5 seconds.

Mode 03 Constant power mode (⤴)

It can be selected within 5–40 seconds, each setting time is 5s.
The curing light works at standard power until the timing ends.
The buzzer will prompt with "di" every 5 seconds.

Mode 04 Super power mode (●)

The time can be selected from 1, 3, 5 seconds within the set time,
the curing light works with super power.

5.3 Specific operation

Step 1:

Press any button to wake up the circuit and enter the standby state.

Step 2:

Press the "M" button to select the required working mode.

Step 3:

After selecting the working mode, press the "T" button to select
the required working time.

Step 4:

After setting the working mode and time, press the power switch
to turn on the curing light.

Prompt:

In the standby state, if no any button is pressed within 50 seconds,
the curing light will automatically shut down.

This curing light has a built-in under-voltage detection function.
When the battery voltage is lower than the set value, it will sound an
alarm and the battery indicator on the screen will flash to indicate
that the user should stop using it and charge it in time.

6. Charging instructions

6.1 Connect the power adapter to the charging base and turn on the
power, and then put the curing light main body into the charging base.
When charging, the base indicator light will flash green, and the base
indicator light will change to a steady green display after the charging
is completed.

6.2 When using the curing light for the first time, please charge it for
at least 4 hours.

7. Precautions

7.1 Please do not turn on the curing light and use it to work while charging.

7.2 When the lens has obvious damage or cracks that affect the light,
please stop using the product immediately and replace with a new lens.

7.3 After charging, the charger plug should be unplugged from the power
socket.

7.4 Do not touch the metal at both ends of the battery to avoid
short-circuit damage to the battery.

7.5 The curing light can not be used in the presence of flammable
anesthesia mixed with air or flammable anesthesia mixed with oxygen
or nitrous oxide.

7.6 If the curing light is not used for a long time, remove the battery.

7.7 After the dental curing light is fully charged, the power plug should
be unplugged. Do not continue to charge for a long time, otherwise the
battery may be damaged.

Warning:

When using the dental curing light, the light source should not
be pointed at the eyes. If an accident occurs, please go to the
hospital for medical treatment quickly.

8. Product contraindications

Patients with heart disease, patients with pacemakers, pregnant
women and young children shall be precautions for application.

9.1 After use, please wipe the working head with a damp cloth with medical alcohol. Do not soak the working head with disinfectant.

9.2 The body cannot be sterilized at high temperature and can be wiped with alcohol.

9.3 When not use the curing light, it can be put into the charging base. Connect the charger to the charging base when charging is needed.

9.4 Please use a cotton swab dipped in a small amount of absolute alcohol to wipe the contacts on the back of the battery and the charging pin of the base regularly, so as to avoid the occurrence of battery charging dissatisfaction due to poor contact.

9.5 This curing light cannot be disassembled and repaired on site by itself except for the replacement of the curing head and battery and the following common faults. If it is malfunctioning, please troubleshoot according to the following methods. If you can't solve it, please contact our company. This manual does not provide detailed circuit diagrams for the time being.

10. Common faults and solutions

Faults	Possible causes	Solutions
No indicator light, no action	<ol style="list-style-type: none"> 1. The battery is dead in the curing light. 2. The battery is damaged. 3. The charging interface is short-circuited, causing the lithium battery to enter the protection state. 4. The main board circuit board is damaged 	<ol style="list-style-type: none"> 1. Connect to the power supply to charge or replace the battery. 2. Replace the battery. 3. Put the curing light into the charging base to charge, then it can return to normal. 4. Contact your local dealer or our company.
Digital display shows Er	The curing light circuit board is faulty.	Send to the maintenance department for repair.

Insufficient light intensity	<ol style="list-style-type: none"> 1. The bulb is aging. 2. The curing light circuit board is damaged. 3. There is resin remaining on the front end of the lens. 	<ol style="list-style-type: none"> 1. Replace with a new bulb 2. Contact the local dealer or our company. 3. Cleaning the lens.
Does not charge after plugging in the power adapter	<ol style="list-style-type: none"> 1. The charging circuit board is damaged. 2. The curing light circuit board is damaged. 	Contact the local dealer or our company.
The use time becomes shorter after the battery is charged	Battery capacity becomes smaller.	Replace a new battery.

If the fault cannot be resolved, please contact your local dealer or our company.

11. Installation and disassembly method of replaceable parts

11.1 Working head

Installation and disassembly method: unplug the working head from the curing light body, align the new working head (metal end with sealing ring) at the front end of the curing light body and insert it to the bottom in a rotating manner. Do not insert it diagonally.

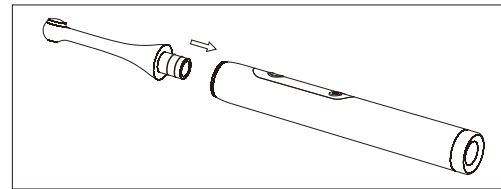

Installation and disassembly method: remove the battery cover at the bottom of the curing light, take out the battery, put the new battery into the body of the curing light, and then close the battery cover.

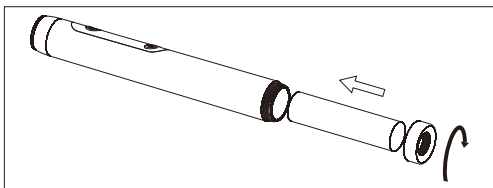











⚠ The above parts are special parts of our company and cannot be purchased. If users need to replace them, please contact our company.

12. Storage and transportation

- 12.1 This equipment should be handled with care, far away from the source of the shake, and should be installed or stored in a cool, dry and ventilated place.
- 12.2 Do not mix with toxic, corrosive, flammable and explosive materials during storage.
- 12.3 The product should be stored in an environment where the relative humidity does not exceed 90%, the atmospheric pressure is 50kPa ~ 106kPa, and the temperature is -25°C ~ +70°C.
- 12.4 During transportation, avoid excessive shock and vibration, handle with care and avoid inversion.
- 12.5 It should not be mixed with dangerous goods during transportation.
- 12.6 Avoid sunlight or rain and snow during transportation.

13. Validity period 5 years.

14. Symbols and description

	Notice! Please refer to the accompanying documents		Refer to instructions for use
	Production date		Fear of rain
	Manufacturer		Sun protection
	Class II		Type B application part
	Up		Handle with care and fragile
	Serial number		

15. After sales service

- 14.1 If this product fails to work normally due to quality problems within one year from the date of sale, our factory is responsible for free maintenance.
- 14.2 The following situations belongs to the scope of paid maintenance:
- 14.2.1 The damage is caused by the user's failure to operate, maintain, and store in accordance with the instructions or the user's carelessness.
- 14.2.2 Because the user disassemble the curing light body by himself/herself.
- 14.2.3 Damaged due to the user use the different performance battery from the original battery.
- 14.2.4 Damaged due to force majeure.
- 14.2.5 Beyond the free maintenance period.

16. Special instructions

- The company reserves the right to modify the machine design, product technology or accessories, user manual and packaging content at any time without notice.
- The product is subject to the actual product, the picture is for reference only.

The product includes:

1. Curing light body 1 pcs
2. Working head 1 pcs
3. Charging base 1 pcs
4. Filter cover 1 pcs
5. User manual 1 pcs
6. Certificate 1 pcs
7. Power adapter 1 pcs

18. Electromagnetic compatibility

Notice

- The dental curing light complies with the electromagnetic compatibility requirements of the YY0505 standard.
- The user should install and use it according to the electromagnetic compatibility information provided by the accompanying documents.
- Portable and mobile RF communication equipment may affect the performance of the dental curing light. Avoid strong electromagnetic interference when using it, such as close to mobile phones, microwave ovens, etc.
- The guidelines and manufacturer's declaration are detailed in the attachment.

Warning

- The equipment or system should not be used close to or stacked with other equipment. If it must be used close or stacked, it should be observed to verify that it can operate normally under the configuration used.
- Except for cables sold by equipment or system manufacturers as spare parts for internal components, the use of accessories and cables other than those specified may result in an increase in the emission of the equipment or system or a decrease in immunity.

19. Product disposal

At the end of the product's life, in order to avoid the harm to the operator's health when it is discarded, and the waste to pollute the environment.

The product must be scrapped in accordance with the local regulations on scrapped medical devices.